

# How Gas-guzzler Conversions Can Accelerate Transportation Electrification

**EV2010VE**

**Vancouver, BC, Canada  
September 16, 2010**

**Ron Gremban, Technical Lead  
The California Cars Initiative  
[rgremban@calcars.org](mailto:rgremban@calcars.org)**

**For updated PDF of presentations:  
[www.calcars.org/downloads](http://www.calcars.org/downloads)**



**CalCars**  
THE CALIFORNIA  
CARS INITIATIVE

[www.calcars.org](http://www.calcars.org) • [info@calcars.org](mailto:info@calcars.org) • PO Box 61045 • Palo Alto, CA 94306



## Oil Consumption is a National Security Issue as Well as a Worldwide Conundrum

- The U.S, for example, imports as much oil as it consumes for transportation, and spends over a \$billion a day on it!
- Oil money funds deep water drilling, tar sands exploitation, and dictatorships.
- To stabilize at 450 ppm, which many believe may still cause a tipping point, the IPCC recommends **20% GHG reductions** (vs. 1990) **by 2020** (80% by 2050)
- Transportation must shoulder its share of GHG reductions, as it accounts for the following percentages of GHG emissions
  - 20% worldwide
  - 30% in the U.S.
  - 40% in California
  - 50% in metro CA



CalCars

THE CALIFORNIA CARS INITIATIVE

[www.calcars.org](http://www.calcars.org)

# Oil Consumption is a National Security Issue as Well as a Worldwide Conundrum

- Even at **10x** the HEV new-vehicle penetration rate, **by 2020**, PEVs will only:
  - Total 21% (100%) of new vehicles  
79% will **still** be **new** ICEs, each guzzling gas for **another** 15+ years!
  - Total 3% (37%) of the fleet
  - Reduce oil consumption by 2% (27%) and carbon emissions by 1% (19%)
  - The numbers in white are for 2030, still at 10x, but are needed by 2020

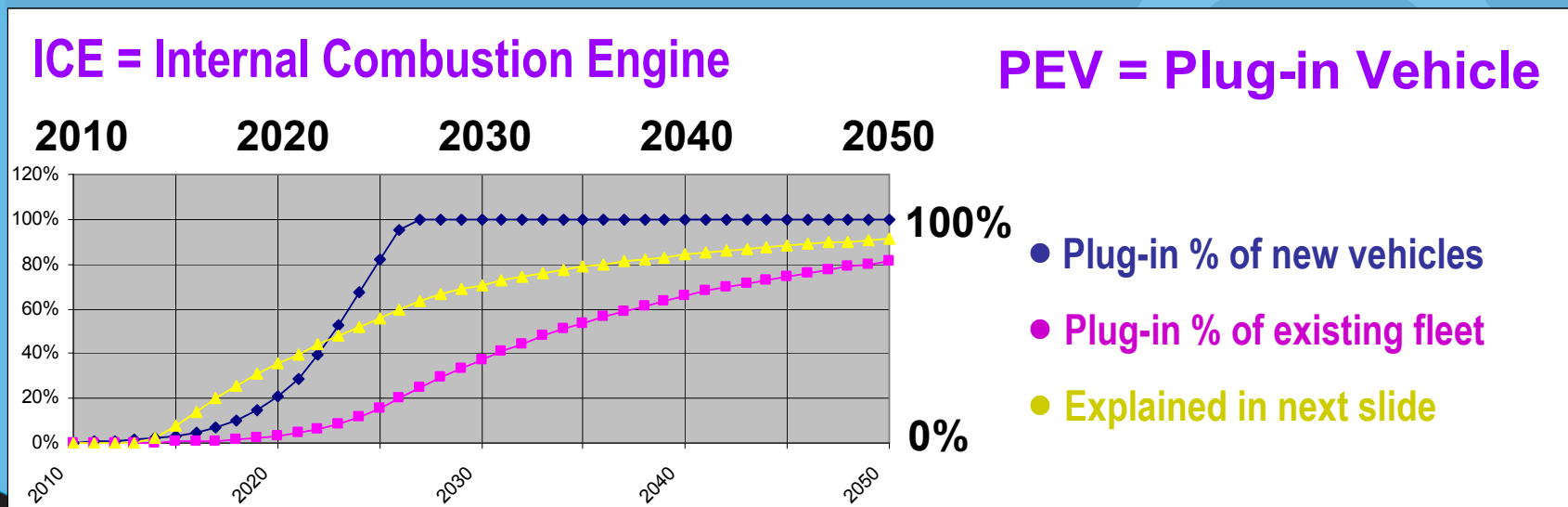

# Mass-produced Conversions Can Accelerate Oil & GHG Reductions by the Decade We Need!

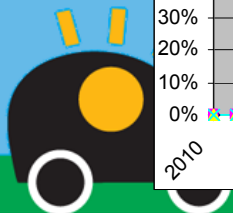
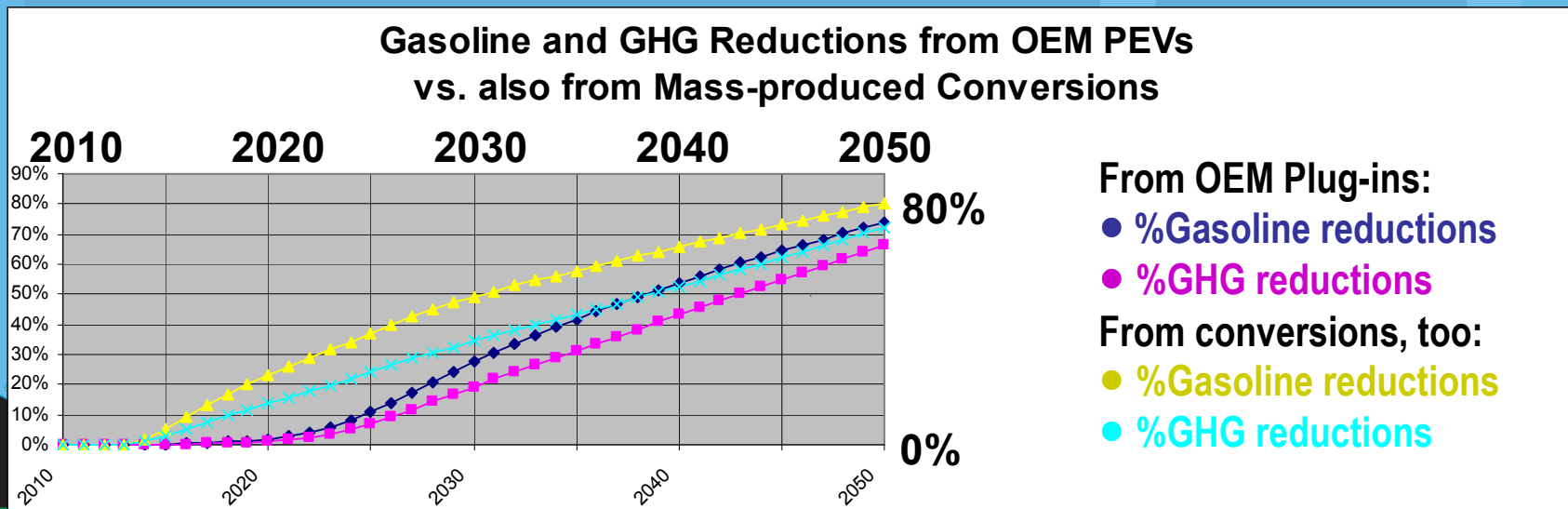
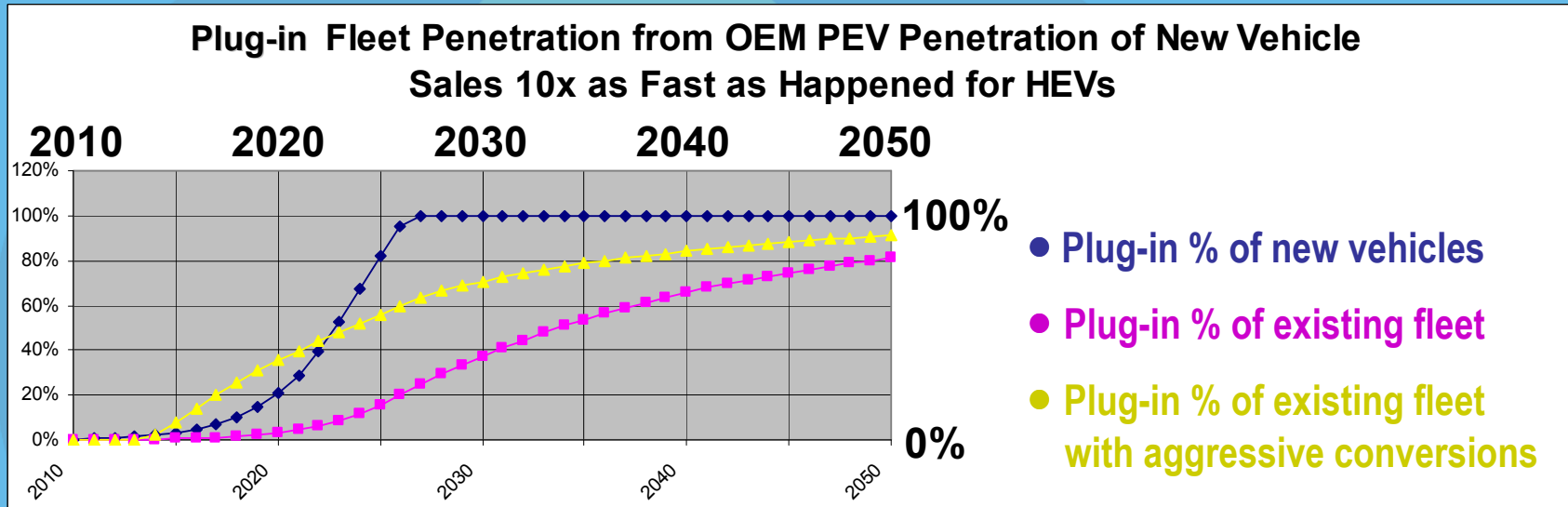

## How Aggressively Must Conversions Ramp Up to Accelerate Reductions by a Full Decade?

- **The super-aggressive conversion ramp-up for the U.S. only**
  - Starts with 1000 conversions in 2010
    - Likely to occur, but most will be HEV->PHEV
  - Ramps up by 10x each year to **10M in 2014**
    - There **are** players preparing to do 10k conversions in 2011
  - Peaks at 18M in 2015
- **Required battery manufacturing capacity**
  - Conversion ramp-up requires an est. total of \$245B investment in new battery production facilities by 2050, peaking at \$57B in 2013
    - This compares to a nearly equal \$236B by 2050 without conversions
  - Currently, because of U.S. stimulus fund investments as well as manufacturers worldwide not wanting to miss the EV opportunity, a glut of EV batteries is expected in the 2-3 years
    - Only conversions can be ramped up quickly enough to take advantage
    - Many factories are being designed for quick expansion, and additional investment is just waiting for known demand



CalCars

THE CALIFORNIA CARS INITIATIVE

[www.calcars.org](http://www.calcars.org)

## Reasons for the 'Big Fix' Strategy of Mass-produced ICE->PEV Conversions

- **Biofuels can help, but**
  - Require huge investments in refineries
  - **Even cellulosic feedstocks can provide no more than 30% of transportation energy**
- **It would be too energy intensive to retire existing vehicles fast enough to accelerate reductions by many years**
  - Worldwide new-vehicle production capacity would have to double to accelerate by a decade
  - **Manufacturing new vehicles** (even with recycled materials) **adds the following 'embedded energy'** to lifetime energy consumption:
    - Today's **ICEVs**: **~15%** on top of lifetime fuel consumption
    - **Efficient BEVs**: **up to 80%** on top of lifetime fuel consumption! (PHEVs are in between)



CalCars

THE CALIFORNIA CARS INITIATIVE

[www.calcars.org](http://www.calcars.org)

## Reasons for the 'Big Fix' Strategy of Mass-produced ICE->PEV Conversions (cont'd)

- At any stage in an existing vehicle's life:
  - A replacement Plug-in vehicle would need to be twice as fuel efficient to save as much as the manufacturing energy lost by crushing its predecessor early.
  - After only 9000 mi, energy savings ensue from converting a vehicle into a Plug-in vehicle
- Rapid conversion of many of the 100M light, medium, and heavy-duty ICE vehicles in the U.S. into BEVs and PHEVs **can accelerate overall oil consumption and GHG reductions by up to a decade!**
- To save that decade without expending even more manufacturing energy, we must fix millions of the 900M (250M in the U.S.) existing vehicles, plus those ICE vehicles still being produced



CalCars

THE CALIFORNIA CARS INITIATIVE

[www.calcars.org](http://www.calcars.org)

## The Low-hanging Fruit: Pickups, Vans, Larger Vehicles, and Those with Defined Drive Cycles

- They use **50% of transportation fuel**; generally have room for batteries
- Due to scale, **conversion cost is lowest per gallon** of fuel saved
- Vehicles with known, limited routes can become BEVs; others, PHEVs
- **Conversions can extend the life of vehicles** in good shape but with aging/gluttonous drivetrains
- **Conversions can be:**
  - Custom designed, tested, and **certified for each** of the most popular **vehicle models** like the F-150
  - Built in recently closed auto assembly plants, **using the projected glut of batteries** from new recently-stimulus-funded factories
  - Installed by local dealers and repair shops, **providing local jobs** across the country

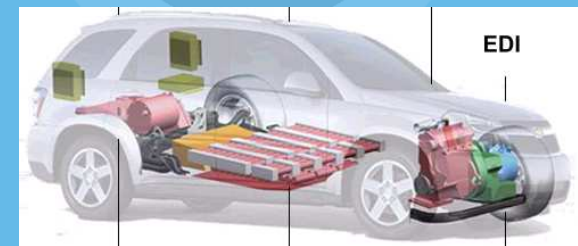

CalCars

THE CALIFORNIA CARS INITIATIVE

[www.calcars.org](http://www.calcars.org)



# The Economics of Gas Guzzler Conversions

- **EER = EV-to-ICE Energy Efficiency Ratio**
  - **4.7 today** (calculated from EPA and Argonne data)
  - **>5.0 for conversions** because of the worse ICE fuel economy of older vehicles
  - Note: CEC conservatively projects 3.0 for 2020
- **PHEV/EREV rule of thumb**, assuming 1 charge/day, independent of vehicle size or type
  - 10x EER gallons per year saved per useful-kWh (battery capacity actually used)
    - At conversion EER=5.0, 50 gallons are saved per year per useful-kWh of battery capacity
    - Not all BEV range can be used each charge: Expect **fleet BEV savings of 33 gal/yr** (2/3)
  - Remaining PHEV/EREV fuel use usually reduced by ~30% due to hybridization
    - Can vary greatly. At 50% electrification, expect **15 gal/yr additional savings per useful-kWh**



CalCars

THE CALIFORNIA CARS INITIATIVE

[www.calcars.org](http://www.calcars.org)

## The Economics of Gas Guzzler Conversions (cont'd)

- Note: for more detail on conversion costs, EER (Energy Efficiency Ratio), and my rule-of-thumb, see my Plug-in 2010 talk and the paper “Conversion Technologies and Costs, Aug 2009”, both at <http://www.calcars.org/ice-conversions.html>.
- Therefore, future fuel savings are proportional to battery cost, which is best considered as a **pre-payment against fuel savings**
  - **Battery financing**, e.g. by a Energy Service Company, and/or **government incentives** can help **bridge the uncertainty gap** until ROI (Return On Investment) is proven and/or prices decline further
  - **Near-term battery costs: \$450/useful-kWh, BEV & blended PHEV; \$800/useful-kWh, EREV**
    - At 65 total PHEV/EREV gal/yr saved per useful-kWh, battery cost, plus ROI at \$3/gallon, is
      - **Blended PHEV: <\$7 per gallon/year saved, ROI = 2.3 years**
      - **EREV: \$12.30 per gallon/year saved, ROI = 4.1 years**
      - **Fleet BEV: (33 gal/yr) <\$14 per gallon/yr saved, ROI = 4.6 years**



## The Economics of Gas Guzzler Conversions (cont'd)

- **3 conversion alternatives (battery examples are for a pickup truck):**
  - **Add PHEV components to the existing drivetrain: ~\$5k + battery**
    - Cheapest but only 1/2 - 2/3 as effective as a new PHEV
    - **1/2 - 2/3 new-vehicle savings at 10-20% of the price (+ battery)**
    - E.g: 10 useful-kWh at \$4500 for a 20-mi EV range, ROI = 2.3 years
  - **Replace the drivetrain with a PHEV/EREV version: ~\$10k + battery**
    - Except for vehicle drag, **can be as effective as a new vehicle, for 20-40% of the price (+ battery)**
    - E.g: 10 useful-kWh at \$8000 for a 20-mi EV range, ROI = 4.1 years
  - **Replace the drivetrain with a BEV drivetrain: ~\$5k + a larger battery**
    - Limited range, but, at **10-20% the price of a new vehicle (+ battery)**, effective e.g. for fleet vehicles with known routes
    - Not having an ICE means the lowest fuel and maintenance costs
    - E.g: 50 useful-kWh at \$22,500 for a 100-mi range, fleet ROI = 4.6 yr



## Canada & Japan policies on conversions

### **Canada's New EV Technology Roadmap provisions**

- “Develop harmonized standards for the conversion of used vehicles to electric traction.”
- “Assess the resource requirements for training, education and certification in skills related to the emerging EV industry. Provide this information to organizations that can develop: 1. technical courses on EV repair, service and maintenance and on the conversion of ICE-based vehicles to EVs.”

### **Ontario's \$10,000 rebate for new plug-in vehicles**

- We **propose and seek allies** to expand this incentive (based on battery size) to include safe, drivable, validated conversions, especially of large gas-guzzlers.

### **Japan's Postal Fleet**

- Converting 25% of 22,000 vehicles to plug in.



CalCars

THE CALIFORNIA CARS INITIATIVE

[www.calcars.org](http://www.calcars.org)

## US measures supporting EV/PHEV conversions

### **Obama campaign and administration**

1 million PHEVs by 2015; *“When it becomes possible in the coming years, we should make sure that every government car is a plug-in hybrid.”*

### **Stimulus measures**

- 10% tax credits up to \$4,000 for conversions (needs to be higher).
- \$3,500-\$4,500 “cash for clunkers:” why not expand to convert, not crush?
- Precedent set by large new programs to retrofit buildings

### **Colorado State Tax Credit: \$6,000 for hybrid conversions**

### **CalCars begins new advocacy program**

- Engaging with stakeholders: small companies, integrators, fleets, NGOs, legislators, Energy Department – and, once credible, eventually OEMs -- to create a broad coalition to launch a new industry.



CalCars

THE CALIFORNIA CARS INITIATIVE

[www.calcars.org](http://www.calcars.org)

## Example Conversion Business: PHEV addition to drivetrain



# Hybrid Electric Vehicle Technologies, Inc.



World's First Plug-in Hybrid Electric Pickup Truck, [hevt.com](http://hevt.com) Chicago IL

- Founder: IIT Prof. Ali Emadi, leading power electronics expert.
- 40 million trucks/buses in U.S; 2 million added annually.
- F-150 prototype design scales to F-250, 350, school and transit buses.
- Simple payback: 2-5 years.

- Uniquely converting America's most popular pickup truck, the Ford F-150, to a plug-in hybrid; more than 15 months of testing.
- Up to 30 miles all-electric range; up to 40% MPG improvement as a hybrid (beyond all-electric range).
- Up to 90 tons of CO2 savings in 12 years; V2G capability; increased low-speed torque for better towing.
- ESTIMATED COST IN VOLUME PRODUCTION: \$15,000 OR LESS.
- Seeking investment funding.



CalCars

THE CALIFORNIA CARS INITIATIVE

[www.calcars.org](http://www.calcars.org)

## Example Conversion Business: PHEV addition to drivetrain



### Poulsen Hybrid, LLC



[poulsenhybrid.com](http://poulsenhybrid.com) Shelton, CT

\$8,600 suggested retail price (before tax incentives) for complete Poulsen Hybrid System installed with 4.5 kWh Lithium-ion batteries, wheel motors and brackets.

- Conversions for the most popular compact cars & SUVs.
- 20-30 mile battery assisted range matches 70% of US daily commutes.
- Four-hour local installation.
- Business model scales to convert tens of thousands/year.
- Creates green authorized installer jobs in communities everywhere.



CalCars

THE CALIFORNIA CARS INITIATIVE

[www.calcars.org](http://www.calcars.org)

## Example Conversion Business: BEV or PHEV drivetrain replacement



# Rapid Electric Vehicle Technologies, Inc.

[rapidelectricvehicles.com](http://rapidelectricvehicles.com)  
Vancouver British Columbia

- Developing partnerships with Canadian dealers.
- All-electric and PHEVs starting with Ford trucks and SUVs.
- Contracts pending with public and private fleets.
- Seeking investment funding.



**REV 300ACX**  
Pure Electric

[Vehicle Details](#)

Max Speed: 100mph / 160 kmh  
Range: Up to 200 km's  
Acceleration: 0-100 <7 seconds  
Charge time: 3.5 hrs at 240V

The image shows a white Ford SUV (likely a Ford Escape) converted into an electric vehicle. The car is parked on a reflective surface at night, with a city skyline in the background. The car has a 'REV' logo on the front grille and a 'REV' badge on the front bumper. The background is a blurred cityscape with lights reflecting on the water.

CalCars

THE CALIFORNIA CARS INITIATIVE

[www.calcars.org](http://www.calcars.org)



## Example Conversion Business: EREV drivetrain replacement



ALTe, LLC

- Staffed by auto industry and Tesla alumni
- Modular approach for vehicles from 2,000 lb to 16,000 lb
- Delivers 80% - 200% fuel economy improvement
- Customers/contracts/ 100 dealer nationwide network
- Aim: 90,000 powertrains annually starting Q1 2011
- Applied for DoE ATVM Loan & seeking \$5 M equity investment

Engineering and mass producing Series PHEV and EV complete powertrain conversion kits and platforms

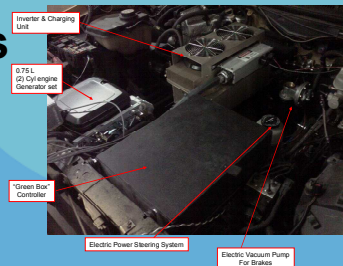

Gen 1 Series PHEV Powertrain in a running Ford Crown Victoria

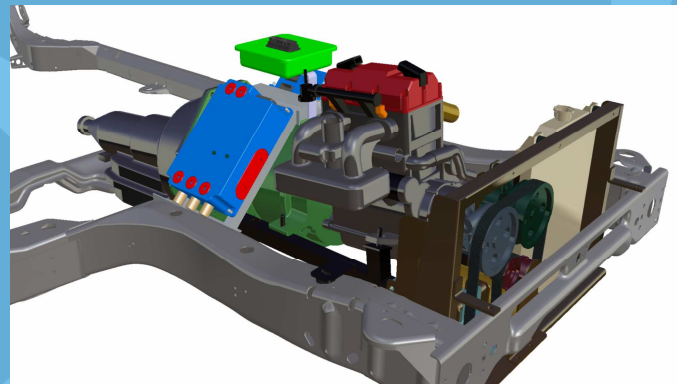

Gen 2 Series PHEV Powertrain in a running rolling chassis



CalCars

THE CALIFORNIA CARS INITIATIVE

[www.calcars.org](http://www.calcars.org)

## Example Conversion Business: PHEV drivetrain replacement



### Efficient Drivetrains Inc.

[efficientdrivetrains.com](http://efficientdrivetrains.com)

San Francisco-  
Sacramento region

- CoFounder & CTO Prof. Andy Frank, UC Davis, inventor of modern PHEV.
- Working with car/truck OEMs, conversions, first-tier suppliers to embed innovative drivetrain system designs, components -- parallel, series, and retrofit technologies.

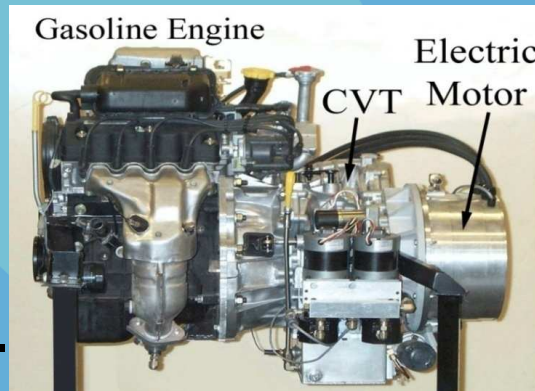

- Patent portfolio: hybrid fundamentals, continuously variable transmissions, energy management systems.
- Projects in U.S., Europe, and Asia : two-wheeler, V2.0 parallel PHEV drivetrain for light and medium duty, inline CVT, CVT integration, and controllers.
- 2008/2009 operations funded from customer revenues.
- Seeking \$2-3M in expansion funding now.



CalCars

THE CALIFORNIA CARS INITIATIVE

[www.calcars.org](http://www.calcars.org)

## Example Conversion Business: PHEV drivetrain replacement



# Bright Automotive

[Brightautomotive.com](http://Brightautomotive.com)  
Anderson, Indiana

- Interim demonstration of technologies in future Bright "IDEA."
- Platform is VW Transporter (world vehicle, not in U.S.)
- Company beginning first prototype.
- Future partnership with VW possible.
- Rocky Mountain. Inst. spinoff

The diagram, titled "Bright Inside", shows a side view of a vehicle chassis with various components labeled: "Engine" at the front, "Battery Pack" in the middle, "Hybrid System Controller" behind the battery, "Charger" at the rear, and "Electric Drive" at the very back. To the left of the diagram are three images: a white VW Transporter van, a partial view of another VW Transporter, and a white pickup truck.

**A PHEV conversion of an existing vehicle for improved fuel economy in your fleet operations**

- Proven platform
- Plug in hybrid electric vehicle
- 22 mile all-electric (EV) range
- 57 mpg based on 50 mile daily cycle
- Cargo, cab-chassis & passenger versions
- Fleet integration Q2 2010



CalCars

THE CALIFORNIA CARS INITIATIVE

[www.calcars.org](http://www.calcars.org)

## Example Conversion Business: PHEV drivetrain replacement



# Raser Technologies

[Rasertech.com.com](http://Rasertech.com.com)

Provo, Utah

- Retrofit Hummer H2
- Precedent: General Motors provided technical support/contact with engineers.
- 40-mile range series PHEV developed with FEV
- Promotion for Raser's Traction Drive System; commercial plans unclear



CalCars

THE CALIFORNIA CARS INITIATIVE

## Key themes: start now for market penetration

- **End Business As Usual (BAU)** to get near/mid-term impact.
- **“Good enough to get started:”** Fixing heavy gas guzzlers can produce **4x the fuel saving/100 miles** driven vs. small passenger cars.
- Without ICE conversions, market penetration is too slow.
- **Equalize tax incentives** for conversions that match new car fuel displacement.
- Conversions preserve energy embedded in vehicles.
- Conversions jumpstart component industry; help small companies go from lab to real world demos and selling to large customers.
- Prizes and other strategies can identify & incentivize startups/experimenters.
- Spark giant new industry: **local green retrofit jobs everywhere.**



CalCars

THE CALIFORNIA CARS INITIATIVE

[www.calcars.org](http://www.calcars.org)

# CalCars: a resource for a broad new campaign

- Subscribe to [CalCars-News](#) & watch [ICE-conversions](#) Page

09/01/09: [Important Developments on Hybrid and Gas-Guzzler Conversions](#)

08/21/09: [Plug-Ins: Industry Developments and Media](#)

08/11/09: [The 21st Century Car Industry: Fixed in the USA](#)

03/27/09: [Our New Guzzler Video; Other Media; Apply for US Billions; GM Book; Correction](#)

01/21/09: [Our Testimony on Conversions Bolstered by 140+ Thoughtful Appeals](#)

11/12/08: [Multiple PHEV Conversion Solutions Gain Momentum](#)

10/03/08: [Should We Crush Gas-Guzzlers? Or Convert Them to Plug In? An Analysis](#)

09/20/08: [Another F-150 Conversion company](#) (Envia Rapid Electric Vehicles)

08/04/08: [Andy Grove's Ambitious Conversions Goals at Plug-In 2008](#)

- Print/distribute PDFs from Downloads Page
- And thanks for all you've done—and will do!



*Donate!*



CalCars

THE CALIFORNIA CARS INITIATIVE

www.calcars.org

# Keep up with issues & emerging companies

- Subscribe to [CalCars-News](#) & watch [ICE-conversions](#) Page

Follow ICE Conversions news, photos; links to companies  
[calcars.org/ice-conversions.html](http://calcars.org/ice-conversions.html)

Download eight-page White Paper and analysis  
[calcars.org/scrap-or-retrofit.html](http://calcars.org/scrap-or-retrofit.html)

CalCars  
THE CALIFORNIA CARS INITIATIVE — 100+ MPG Hybrids

POPULAR: [Convert Big Gas-Guzzlers to Plug In](#) | [Research Analysis: Scrap Or Retrofit Clunkers](#)

Plug-In Hybrids Use Cheaper, Cleaner, Domestic Energy

Quick Takes  
[How to Get a PHEV](#)  
[Where PHEV Conversions Are](#)

9/20/09 DRAFT: *The Big Fix: 16 Founding Points for the Campaign to Upgrade Gas Guzzlers*



Download flyer;  
endorse campaign

Watch our video  
[calcars.org/audio-video.html](http://calcars.org/audio-video.html)  
[www.calcars.org](http://www.calcars.org)